

Article number: 25150264002

Description: ICME Single-phase motor MD90 Sb2 1,5KW
2 - 2800 rpm 1x230 Volt 50Hz B5 with starting & running capacitor

Measures

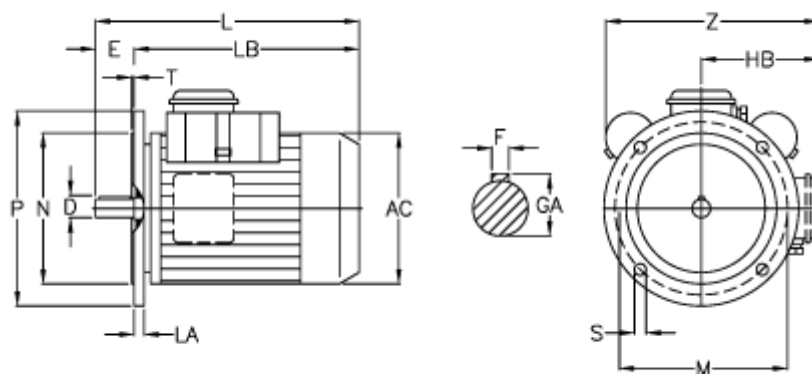

AC = 176	LB = 292
D = 24	M = 165
E = 50	N = 130
F = 8	P = 200
GA = 27.0	S = 11.5
HB = 129	T = 3.5
L = 342	Z = 246
LA = 12.0	